

Frank Türen AG
T 041 624 90 90
www.frank-tueren.ch

Futtersür EI30, 1-flügelig, Rahmentürblatt mit Glas- oder Füllungseinsatz

Massangaben in mm

VKF Nr. 23698

Masstab 1:25 Seite 2

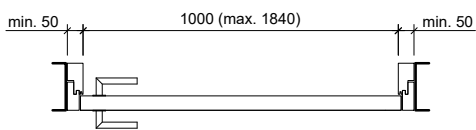
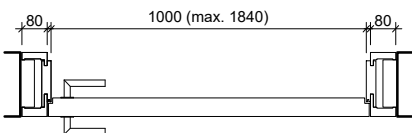
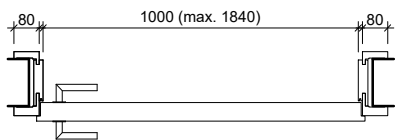
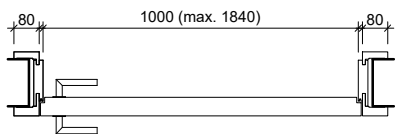
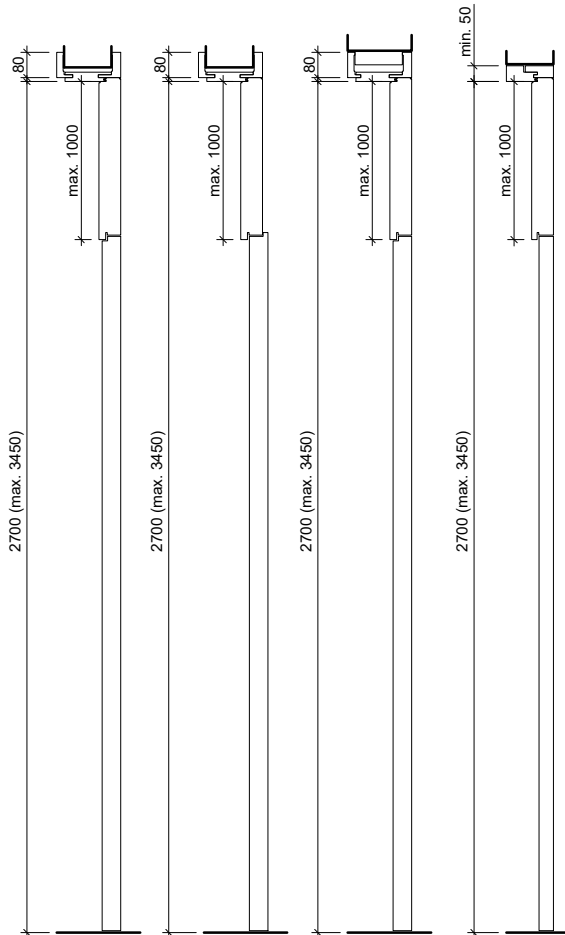
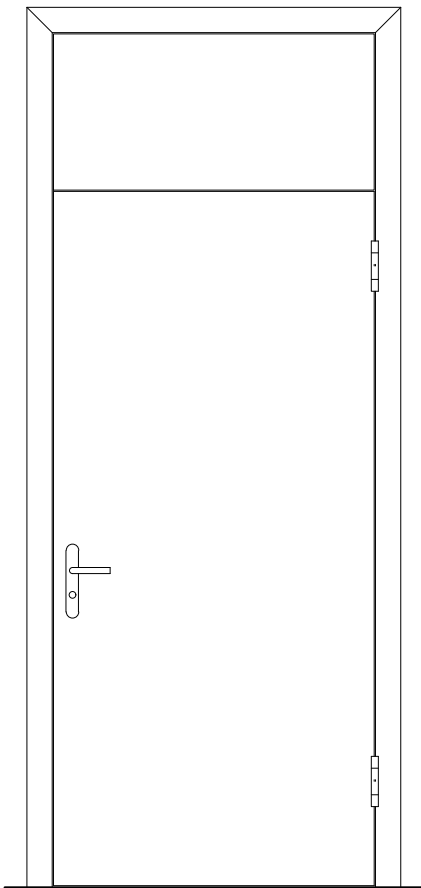

Frank Türen AG
 T 041 624 90 90
 www.frank-tueren.ch

**Futtertür EI30, 1-flügelig, Volltürblatt mit Oberteil
 mit/ohne Glas- oder Füllungsausschnitt**

Massangaben in mm

VKF Nr. 23677, 23717

Massstab 1:25 Seite 3

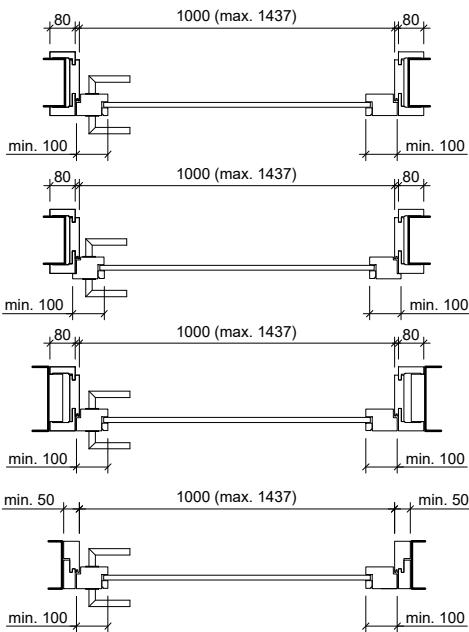
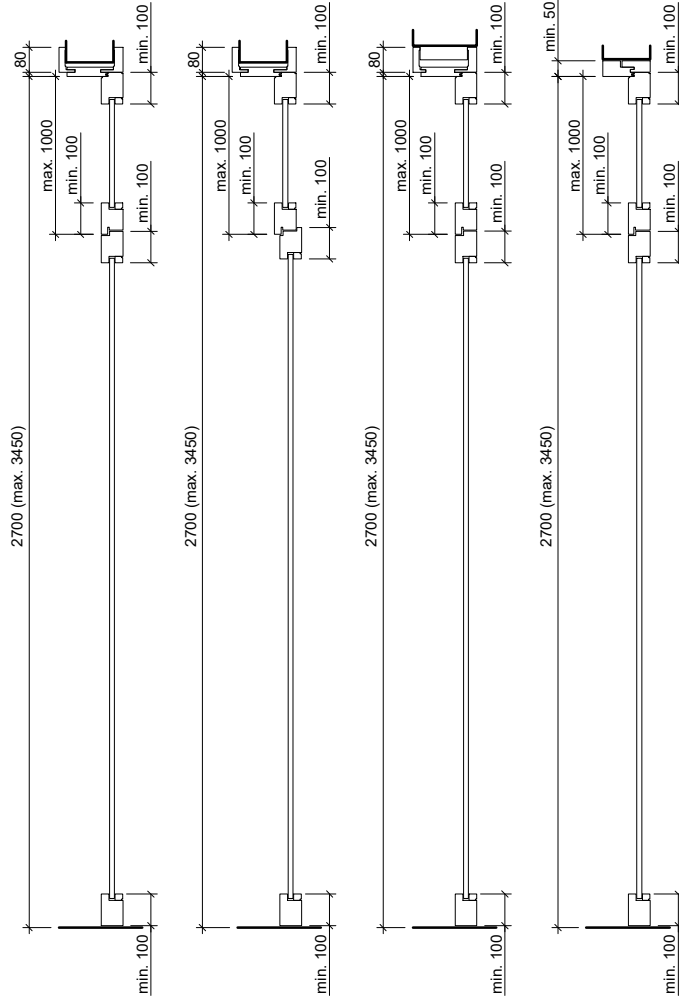
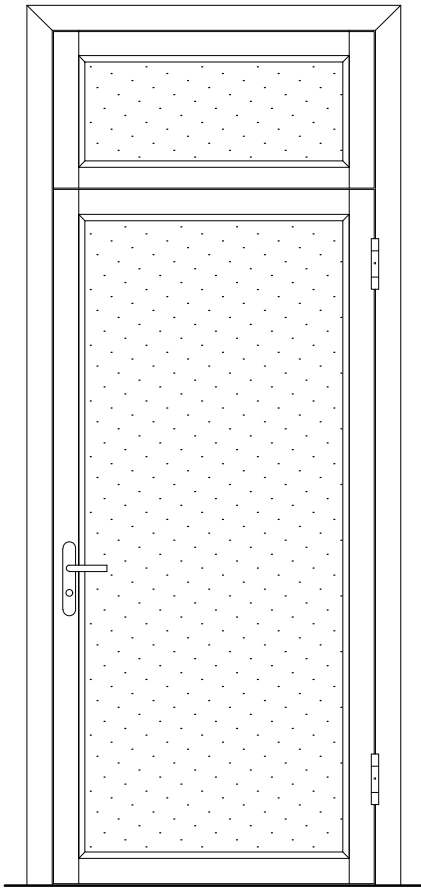

Frank Türen AG
T 041 624 90 90
www.frank-tueren.ch

**Futtertür EI30, 1-flügelig, Rahmentürblatt mit Oberteil
mit/ohne Glas- oder Füllungseinsatz**

Massangaben in mm

VKF Nr. 23698

Masstab 1:25 Seite 4

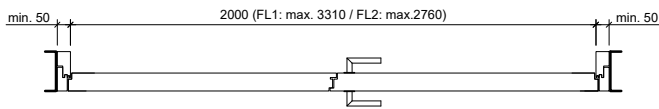
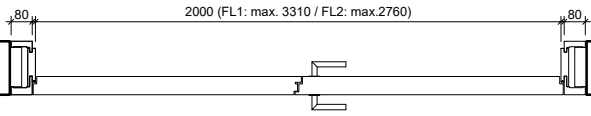
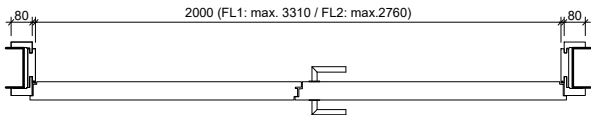
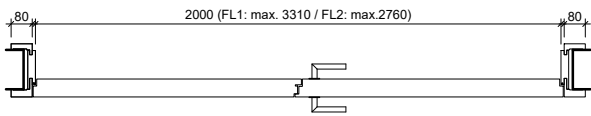
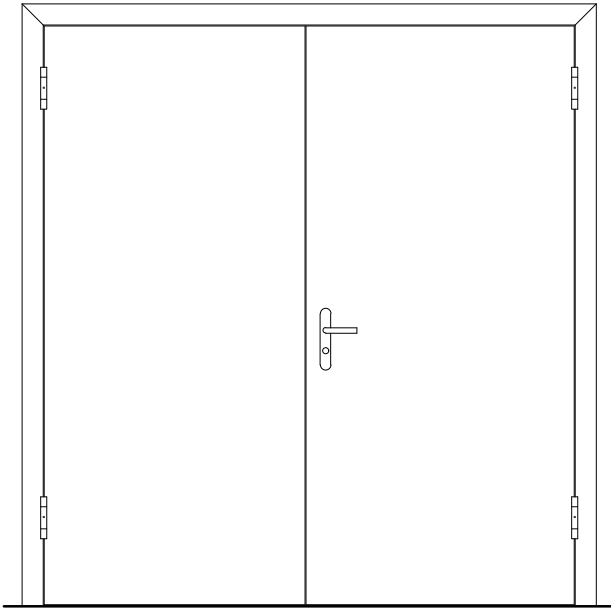

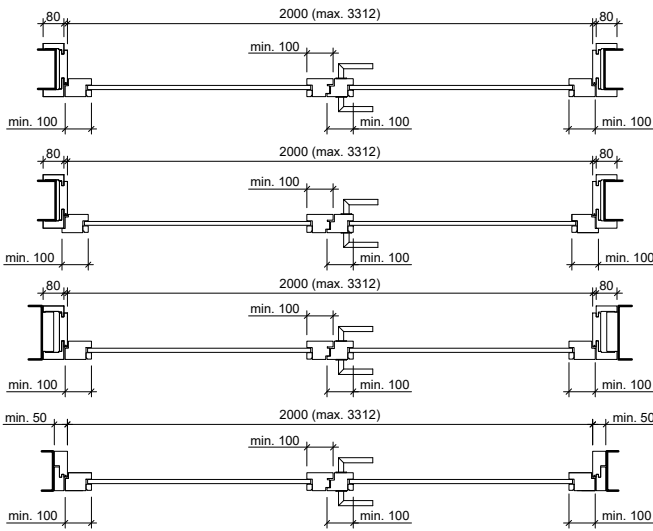
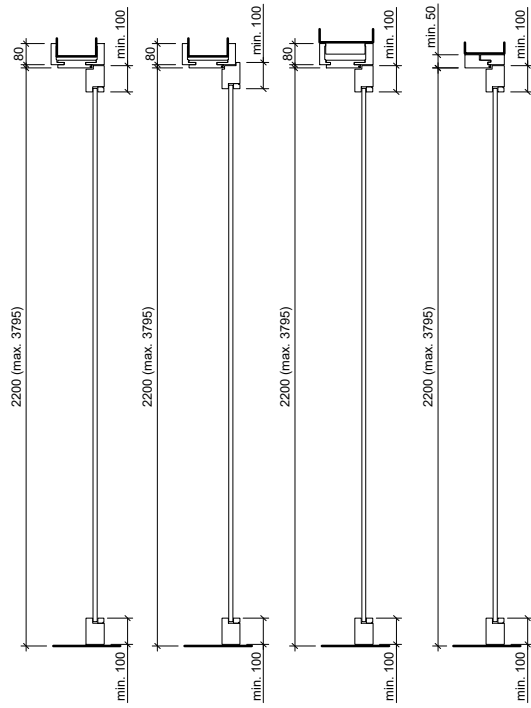
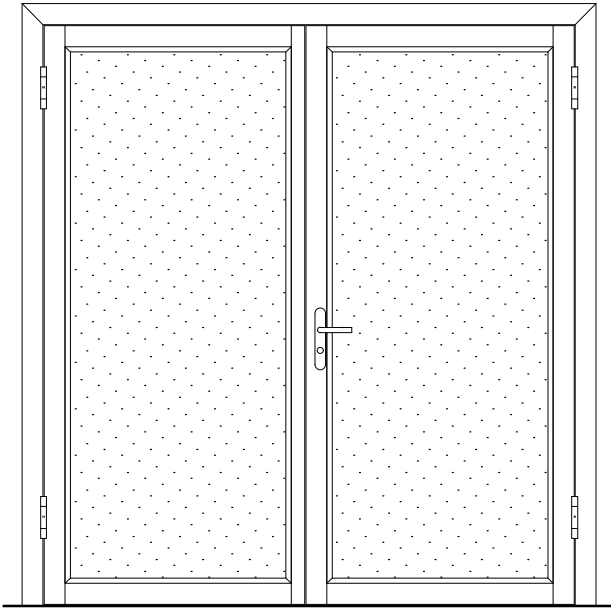

Frank Türen AG
T 041 624 90 90
www.frank-tueren.ch

**Futtertür EI30, 2-flügelig, Rahmentürblatt mit/ohne
Glas- oder Füllungseinsatz**

Massangaben in mm

VKF Nr. 23700

Masstab 1:30 Seite 6

